

Article number: 203180M2075C4T

Description: E+G levelling foot

GN 31-80-M20-75-C4-T

Note: T Without nut, Wrench flat at the bottom

## Measures

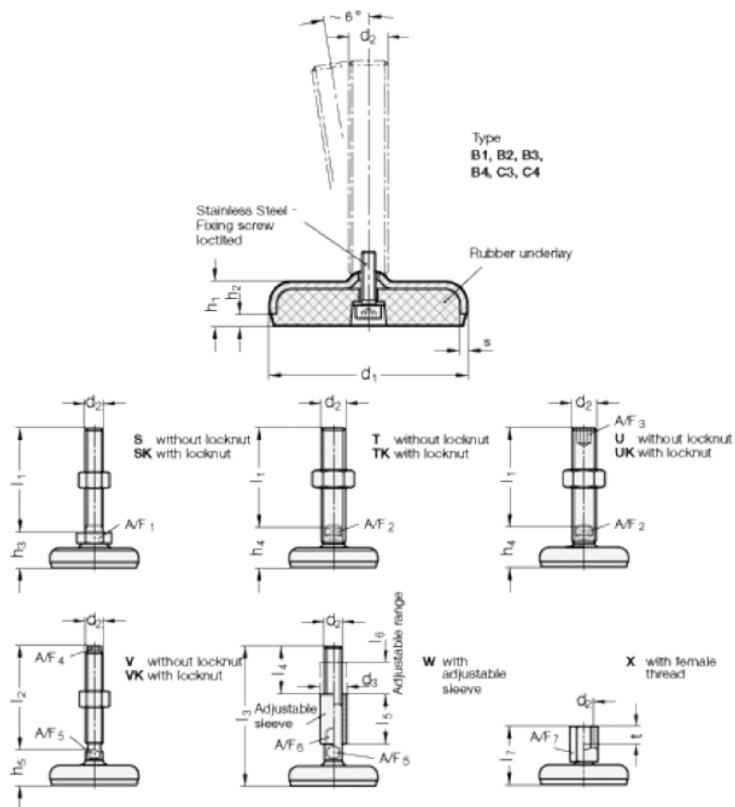

A/F2	= 15
d1	= 80
d2	= 20
h1	= 18
h2	= 5
h4 +4.0/0	= 33
l2	= 75
s	= 3